

版本 REV.	日期 DATE	ECN NO.	变更内容 DESCRIPTION	制图 DRAWN

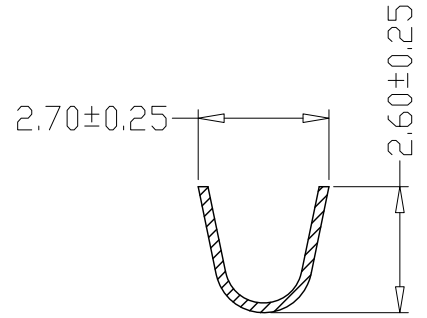

SEC: A-A

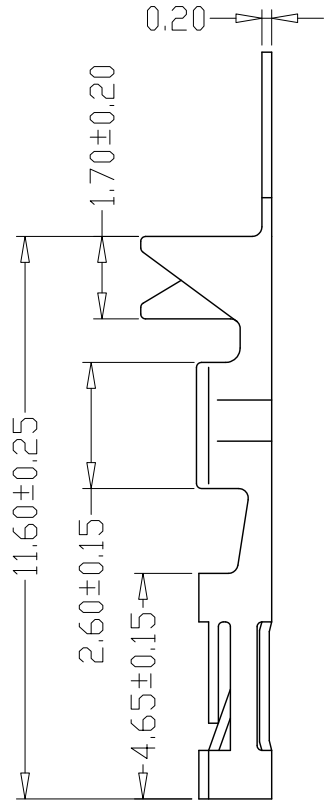
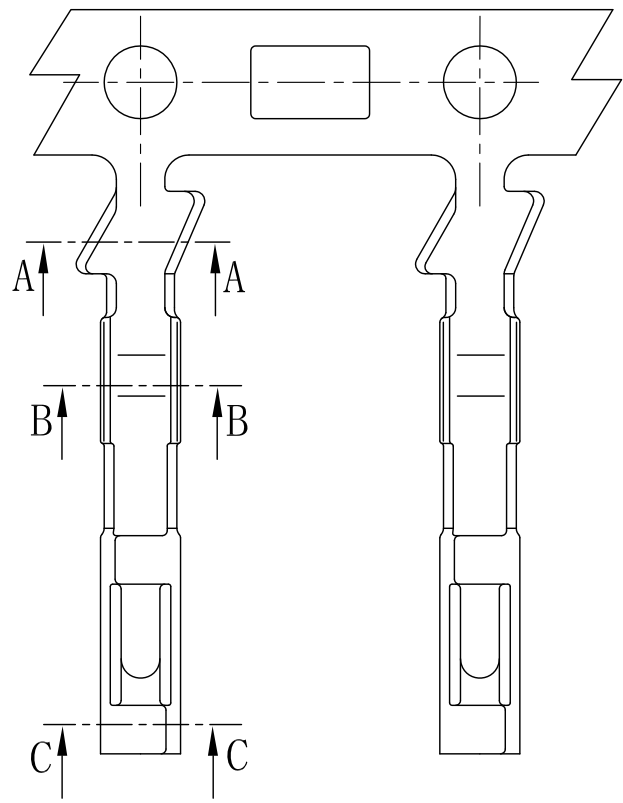
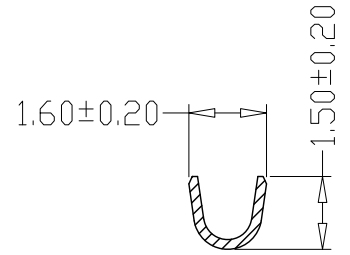

SEC: B-B

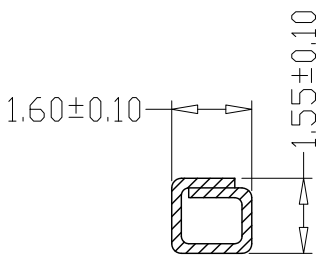

SEC: C-C

SPECIFICATIONS

- 1、Current Rating: 3A AC, DC
- 2、Voltage Rating: 250V AC, DC
- 3、Temperatuer Range: -25°C ~ +85°C
- 4、Contact Resistance: 20mΩ Max
- 5、Insulation Resistance: 1000MΩ Min
- 6、Withstanding Voltang: 1500V AC/minute
- 7、Material: Phosphor Bronz Tin-plated
- 8、Applicable Wire Sizes: AWG#22~26#

GENREL TOLERANCE		制图 Mapping	张迎春 2022、09、18	料号 PART NO.	A25402-T	版本 REV.	A
X±0.25	X°±2°	审核 Audit	钱岳生 2022、09、18	品名 TITLE	2.54杜邦带锁端子	页次 SHEET	1/1
.X±0.25	.X°±1°	核准 Approved	张名 2022、09、19	客户料号 CUTM. NO.		乐清市宏一电子有限公司 YueQing HongYi Electronics Co., Ltd	
.XX±0.15	.XX°±0.5°	单位 Units	mm	比例 SCALE			
.XXX±0.10	.XXX°±0.5°						

版本 REV.	日期 DATE	ECN NO.	变更内容 DESCRIPTION	制图 DRAWN

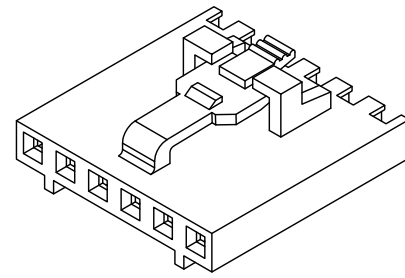
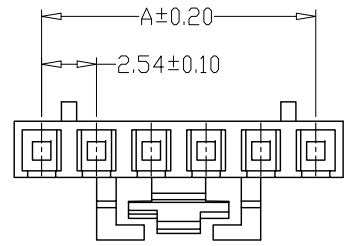

SPECIFICATIONS

- 1、Current Rating: 3A AC, DC
- 2、Voltage Rating: 250V AC, DC
- 3、Temperatuer Range: -25℃~+85℃
- 4、Contact Resistance: 20mΩ Max
- 5、Insulation Resistance: 1000MΩ Min
- 6、Withstanding Voltang: 1500V AC/minute
- 7、Material: PA66, UL94V-0

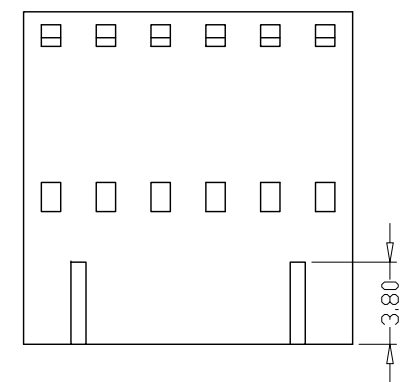
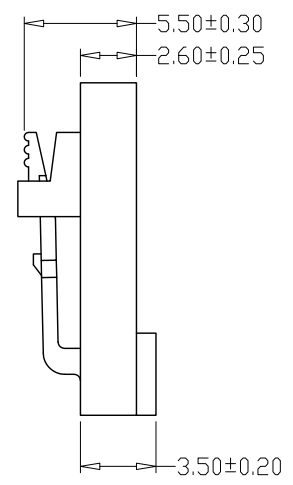
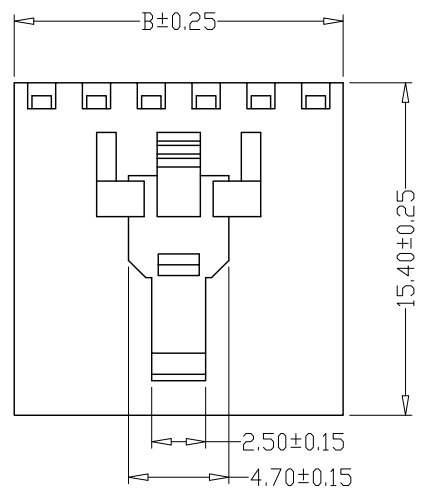

PIN	尺寸 (mm)	
	A	B
-02Y	2.54	5.08
-03Y	5.08	7.62
-04Y	7.62	10.16
-05Y	10.16	12.70
-06Y	12.70	15.24
-07Y	15.24	17.78
-08Y	17.78	20.32
-09Y	20.32	22.86
-10Y	22.86	25.40
-11Y	25.40	27.94
-12Y	27.94	30.48
-13Y	30.48	33.02
-14Y	33.02	35.56
-15Y	35.56	38.10

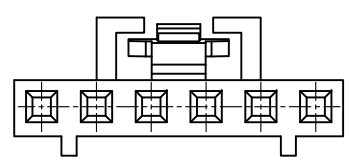

GENEAL TOLERANCE		制图 Mapping	张迎春 2022、09、18	料号 PART NO.	A25402-nY	版本 REV.	A
X.±0.25	X.°±2°	审核 Audit	钱岳生 2022、09、18	品名 TITLE	2.54杜邦带锁孔座	页次 SHEET	1/1
.X±0.25	.X°±1°	核准 Approved	张名 2022、09、19	客户料号 CUTM. NO.			
.XX±0.15	.XX°±0.5°	单位 Units	mm	比例 SCALE			
.XXX±0.10	.XXX°±0.5°						

乐清市宏一电子有限公司  
YueQing HongYi Electronics Co., Ltd

版本 REV.	日期 DATE	ECN NO.	变更内容 DESCRIPTION	制图 DRAWN

SPECIFICATIONS

- 1、Current Rating: 3A AC, DC
- 2、Voltage Rating: 250V AC, DC
- 3、Temperatuer Range: -25°C~+85°C
- 4、Contact Resistance: 20mΩ Max
- 5、Insulation Resistance: 1000MΩ Min
- 6、Withstanding Voltang: 1500V AC/minute
- 7、Material: Wafer PA66, UL94V-0  
PIN Brass Gold-plated

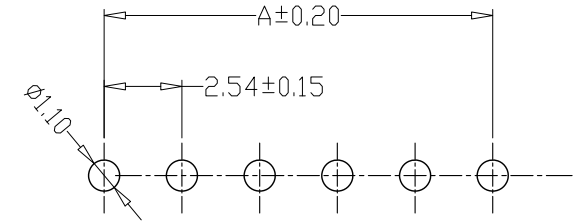
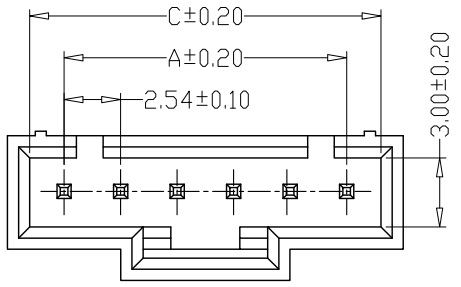

PCB LAYOUT

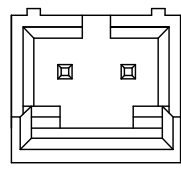
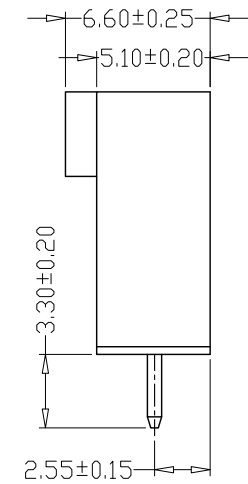
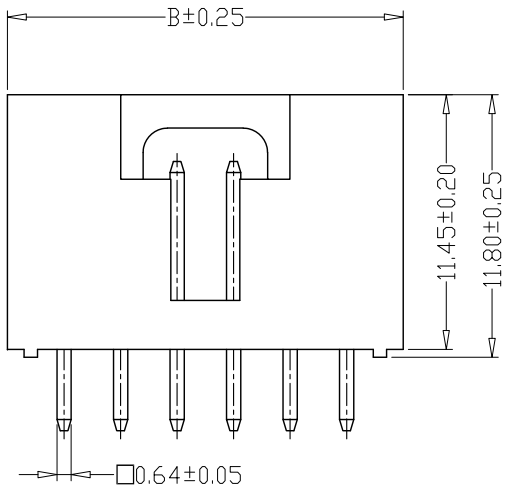
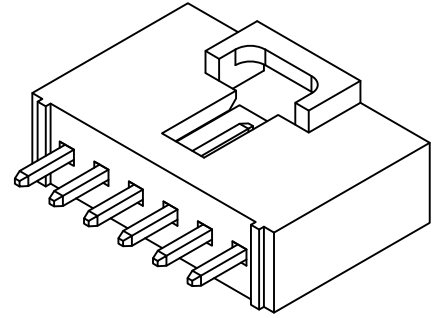

2A

PIN	尺寸 (mm)		
	A	B	C
-02A	2.54	7.62	5.60
-03A	5.08	10.16	8.14
-04A	7.62	12.70	10.68
-05A	10.16	15.24	13.22
-06A	12.70	17.78	15.76
-07A	15.24	20.32	18.30
-08A	17.78	22.86	20.84
-09A	20.32	25.40	23.38
-10A	22.86	27.94	25.92
-11A	25.40	30.48	28.46
-12A	27.94	33.02	31.00
-13A	30.48	35.56	33.54
-14A	33.02	38.10	36.08
-15A	35.56	40.64	38.62

GENERAL TOLERANCE		制图 Mapping	张迎春 2022、09、18	料号 PART NO.	A25402-nA	版本 REV.	A
X±0.25	X°±2°	审核 Audit	钱岳生 2022、09、18	品名 TITLE	2.54杜邦带锁直针真座 WAFER DIP TYPE	页次 SHEET	1/1
.X±0.25	.X°±1°	核准 Approved	张名 2022、09、19	客户料号 CUTM. NO.			
.XX±0.15	.XX°±0.5°	单位 Units	mm	比例 SCALE			
.XXX±0.10	.XXX°±0.5°			<b>乐清市宏一电子有限公司</b> YueQing HongYi Electronics Co., Ltd			

版本 REV.	日期 DATE	ECN NO.	变更内容 DESCRIPTION	制图 DRAWN

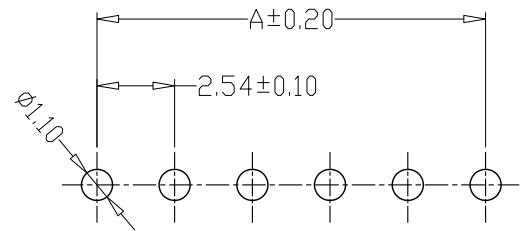
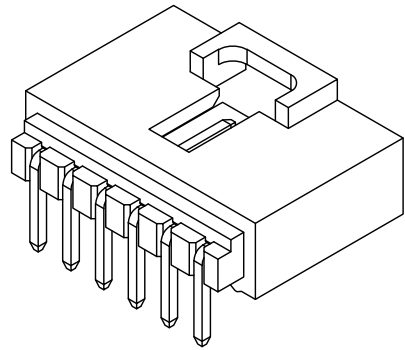
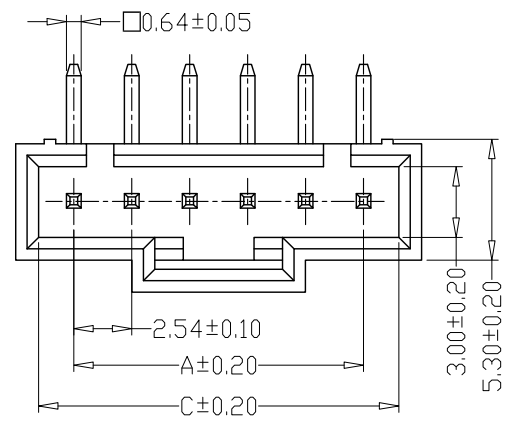

PCB LAYOUT

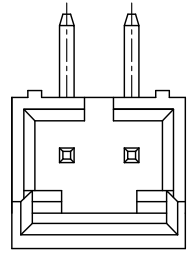
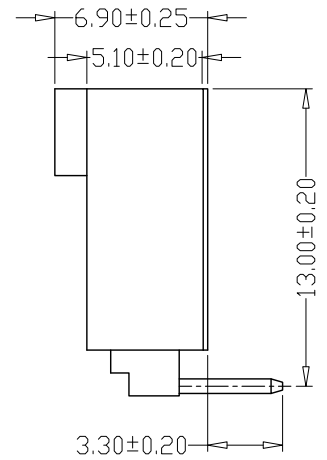
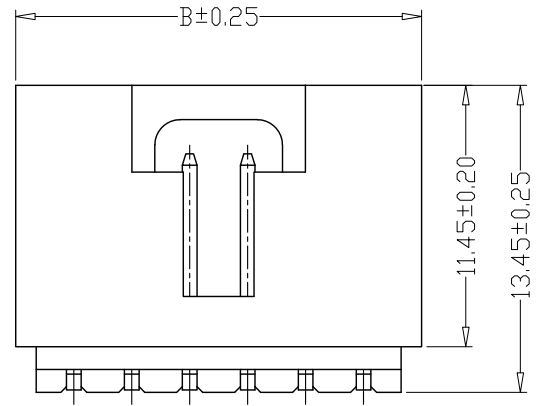

2A

PIN	尺寸 (mm)		
	A	B	C
-02AW	2.54	7.62	5.60
-03AW	5.08	10.16	8.14
-04AW	7.62	12.70	10.68
-05AW	10.16	15.24	13.22
-06AW	12.70	17.78	15.76
-07AW	15.24	20.32	18.30
-08AW	17.78	22.86	20.84
-09AW	20.32	25.40	23.38
-10AW	22.86	27.94	25.92
-11AW	25.40	30.48	28.46
-12AW	27.94	33.02	31.00
-13AW	30.48	35.56	33.54
-14AW	33.02	38.10	36.08
-15AW	35.56	40.64	38.62

SPECIFICATIONS

- Current Rating: 3A AC, DC
- Voltage Rating: 250V AC, DC
- Temperatuer Range: -25°C~+85°C
- Contact Resistance: 20mΩ Max
- Insulation Resistance: 1000MΩ Min
- Withstanding Voltang: 1500V AC/minute
- Material: Wafer PA66, UL94V-0  
PIN Brass Gold-plated

GENERAL TOLERANCE		制图 Mapping	张迎春 2022、09、18		料号 PART NO.	A25402-nAW		版本 REV.	A
X±0.25	X°±2°	审核 Audit	钱岳生 2022、09、18		品名 TITLE	2.54杜邦带锁弯针针座 WAFER DIP TYPE		页次 SHEET	1/1
.XX±0.25	.X°±1°	核准 Approved	张名 2022、09、19		客户料号 CUTM. NO.				
.XXX±0.10	.XXX°±0.5°	单位 Units	mm	比例 SCALE					

乐清市宏一电子有限公司  
YueQing HongYi Electronics Co., Ltd